



# USER MANUAL

---

Version: VT27WGV1

Thank you for purchasing this Vieunite Product.

To receive more complete service, please contact Vieunite support at: [support@vieunite.com](mailto:support@vieunite.com)

---

# Warning! Important Safety Instructions



Please read the Safety Instructions before using your Textura digital canvas.

- The slots and openings on the back or bottom of the canvas are provided for necessary ventilation. To ensure reliable operation of the Textura digital canvas and to protect it from overheating, these slots and openings must never be blocked or covered.
  - Do not place the digital canvas in a confined space, such as a bookcase or built-in cabinet, unless proper ventilation is provided.
  - Do not place the digital canvas near or over a radiator, heat register, or exposed to direct sunlight.
  - Do not place vessels (vases etc.) containing water on the digital canvas, as this can result in a fire or electric shock.
- Do not expose the digital canvas to rain or place it near water (near a bathtub, washbowl, kitchen sink, or laundry tub, in a wet basement, or near a swimming pool, etc.). If the digital canvas accidentally gets wet, unplug it and contact an authorised dealer immediately.
- Do not overload wall outlets, extension cords, or adaptors beyond their capacity, since this can result in fire or electric shock.
- Power-supply cords should be placed in a way that protects them from being walked on or pinched by items placed upon or against them. Pay particular attention to cords at the plug end, at wall outlets, and at the point where they exit from the appliance.
- To protect the digital canvas from a lightning storm, or when left unattended and unused for long periods of time, unplug it from the wall outlet and disconnect the antenna or cable system. This will prevent damage to the set due to lightning and power line surges.
- To avoid electric shock, never touch the inside of the digital canvas. Only a qualified technician should open the digital canvas.
- Be sure to plug in the power cord until it is firmly seated. When unplugging the power cord from a wall outlet, always pull on the power cord's plug and never by pulling on the power cord. Do not touch the power cord with wet hands.
- If the digital canvas does not operate normally, in particular, if there are any unusual sounds or smells coming from the device, unplug it immediately and contact an authorised dealer or service centre.
- Be sure to contact the authorised Vieunite customer service for information if you intend to install your Textura digital canvas in a location with heavy dust, high or low temperatures, high humidity, or in close proximity to chemical substances. Failure to do so may lead to serious damage to your canvas.
- Use only a properly grounded plug and wall outlet.
  - An improper ground may cause electric shock or equipment damage. (Class I Equipment only.)
- To turn off the digital canvas completely, disconnect it from the wall outlet. To ensure you can unplug the digital canvas quickly, if necessary, make sure that the wall outlet and power plug are easily accessible.
- Do not drop or strike the product. If the product is damaged, disconnect the power cord and contact the authorised Vieunite customer service team.

- 
- To clean the digital canvas, unplug the power cord from the wall outlet and wipe the product with a soft, dry cloth. Do not use any chemicals such as wax, benzene, alcohol, thinners, insecticide, aerial fresheners, lubricants, or detergents. These chemicals can damage the appearance of the panel or erase the printing on the product.
  - Do not expose the digital canvas to dripping or splashing.

---

# Performing the initial setup

This guide section aims to assist in the swift setup and utilisation of the Textura digital canvas. For detailed instructions on operating the unit, please consult the main section of the User Guide. To proceed, kindly adhere to the provided step-by-step instructions:

1. Unpack unit and place in the desired location.



2. Using the cable provided, insert the connection into the plug socket, and the type C into the canvas.



---

3. Download the Vieunite application using the QR code.

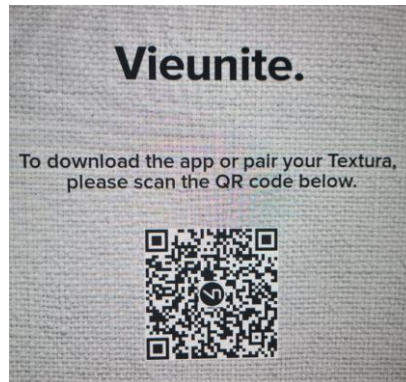

4. Open the application on your device.



---

## Pairing your Canvas

The Textura digital canvas is designed to seamlessly pair with the application and your associated account. To make use of the canvas kindly follow the provided instructions below:

1. Begin by creating an account on the Vieunite application and logging in to the application.

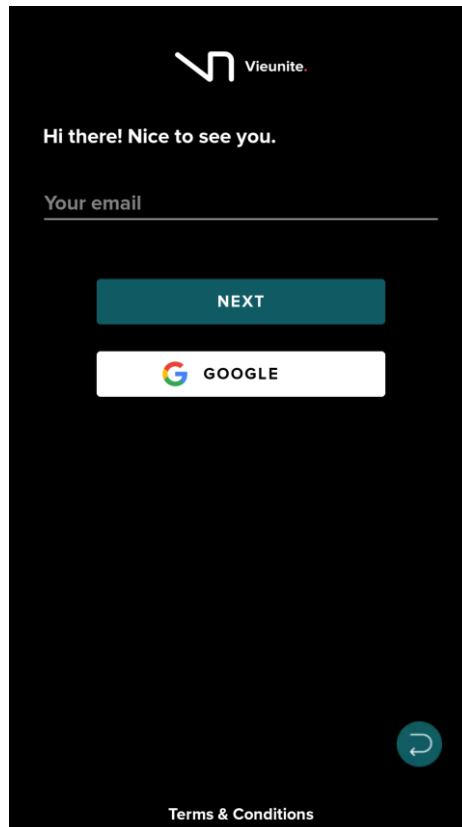

2. Next, tap on the device section as pictured below.



- 
3. Tap on “Pair your Canvas”.



4. Ensure Bluetooth is turned on, this will scan for the canvas.

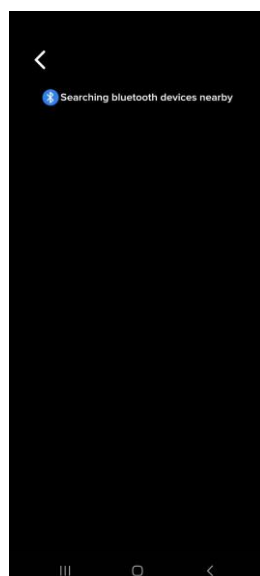

- 
5. Tap "Next" after the device has been successfully detected.

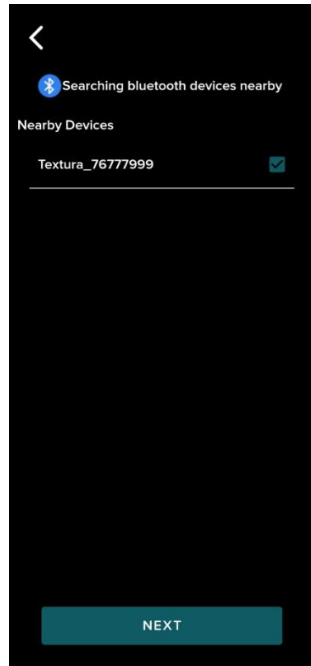

6. Once connected, input your Wi-Fi information.

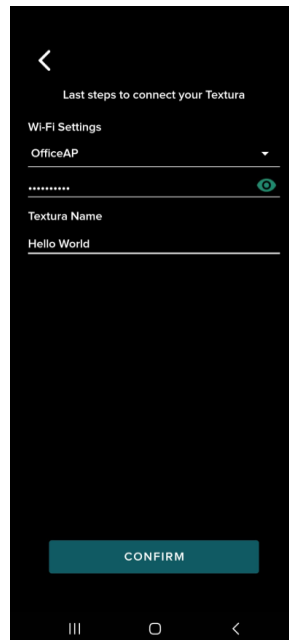

7. Your screen should then automatically pair to your account and you can begin sharing your artwork onto the screen.

# Uploading art

- 1. To upload art and photography to the application, you can easily do so by tapping the "+" button on the home page upon launching the Vieunite application.

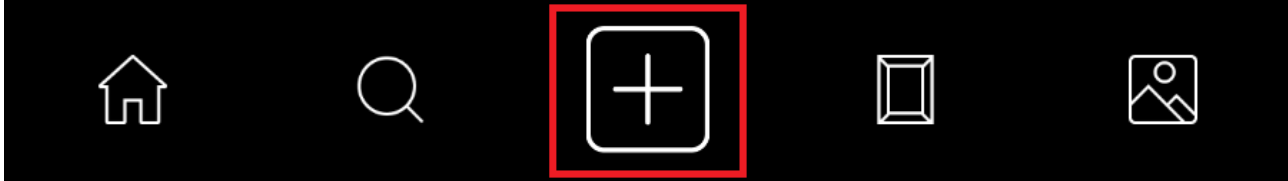

- 2. Select the artwork you wish to upload and tap "next".

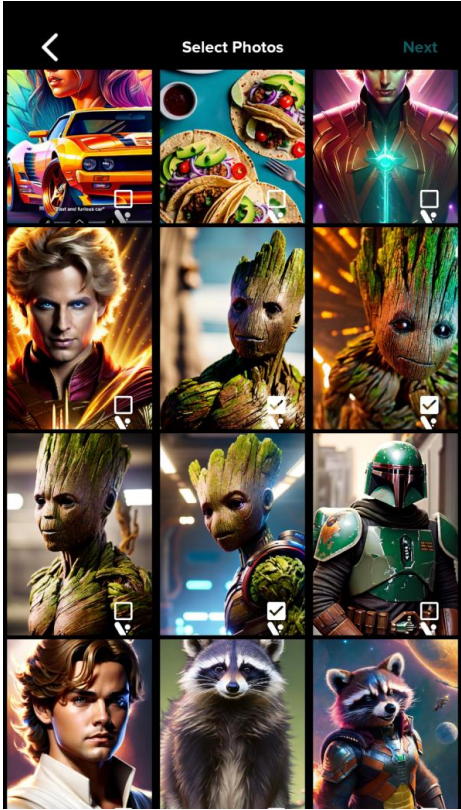

- 
3. Click on “**upload**” when you have adjusted your artwork to the desired results.

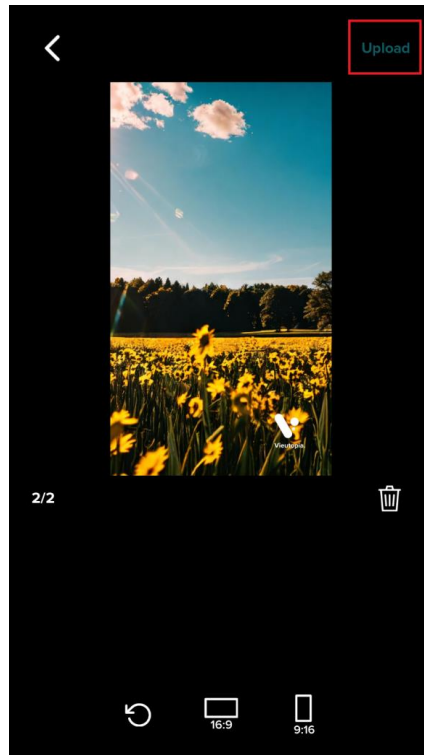

4. Your art will then be able to be viewed within your library, or on your profile.

# Sending art to the canvas

- 1. To send art and photography to your canvas, you can simply tap on the Library icon located in the navigation menu upon launching the application.



- 2. Tap on the art you wish to display on your canvas.



- 3. Tap on the settings icon on the top right section of the image to proceed sending it to your canvas.

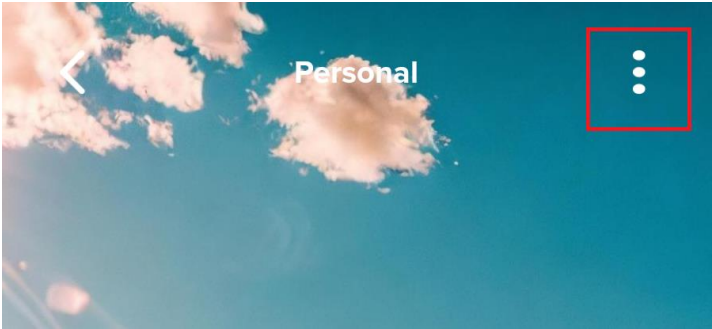

- 
4. Tap on “send to Textura”.

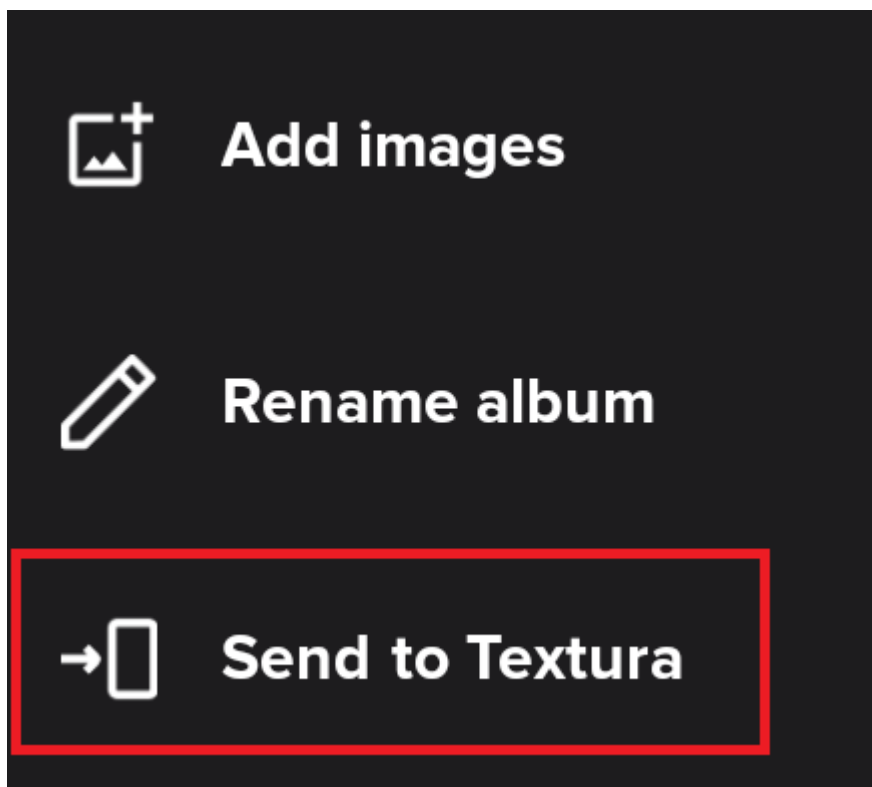

5. You should now see your art appear on your canvas.

---

## Contents

<b>Performing the initial setup</b> .....	<b>3</b>
Pairing your Canvas .....	5
Uploading art .....	8
Sending art to the canvas .....	10
<b>Introduction</b> .....	<b>14</b>
What’s in the box? .....	14
<b>Assembling the Textura Digital Canvas</b> .....	<b>15</b>
Installation .....	15
Ventilation.....	20
Supported Media Formats.....	20
<b>Navigating the Mobile App</b> .....	<b>21</b>
Login screen.....	21
Signing up .....	22
Homepage .....	23
Navigational Menu .....	23
Search page .....	24
Uploading art .....	26
User Options .....	27
Library .....	28
Album .....	29
Artist Dashboard.....	30
Canvas page.....	31
Pairing Your Canvas - Bluetooth.....	32
Pairing Your Canvas - QR Code .....	33
Canvas Settings.....	34
Art Selection .....	35
Purchasing Art .....	36
<b>FAQs and Troubleshooting Guide</b> .....	<b>37</b>
My art looks stretched, unfocused or blurry .....	37
How do I reset my device to factory default? .....	38
My Device won’t turn on .....	38

---

Managing Images on your Canvas: .....	39
<b>Specifications and Other Information .....</b>	<b>40</b>
Product Overview .....	40
Technical specifications .....	40
Environmental Considerations.....	41
Decreasing power consumption .....	41
Disposal .....	41
Warnings .....	41
Warranty.....	42
<b>Ongoing Improvements &amp; Future Updates .....</b>	<b>43</b>

---

# Introduction

Congratulations on your purchase of our product. Prior to its initial use, we kindly ask you to thoroughly read and follow all instructions provided in the manual. It is important to note that the Textura digital canvas should not be exposed to dripping or splashing liquids; and objects filled with liquids, such as vases, should not be placed on the product.

To enhance user convenience, numerous operations can be performed through the "Vieunite application."

## Attention:

1. Do not change any default setting unless necessary.
2. Keep the product far away from water during installation and use.

## What's in the box?

Please ensure that all the following items are included with your Textura digital canvas. If any items are missing, kindly reach out to your supplier for assistance.

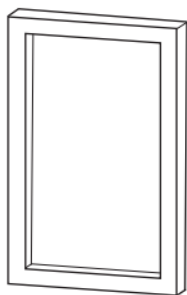

1 x Textura Frame



1 x Digital canvas



4 x Mounting screws  
& wall plugs



Double sided tape

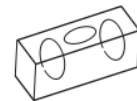

1 x Spirit level



2 x Plug adapters (UK/EU)

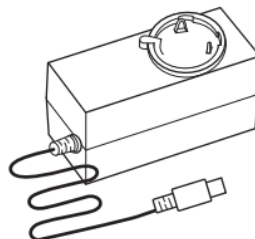

1 x Power cable

- The items' colours and shapes may vary depending on the models.
- Cables not included can be purchased separately.
- Check for any accessories hidden behind or in the packing materials when opening the box.
- Please retain your screen's packaging for the duration of your warranty.

---

# Assembling the Textura Digital Canvas

## Installation

To ensure the longevity of the Textura digital canvas, we strongly advise against installing this product in areas with high humidity, such as kitchens or bathrooms. Furthermore, it is important to retain all product packaging for warranty purposes.

1. Remove the Textura canvas from the box along with all of the accessories.
2. Discard the traceless tape that is on the four corners of the wooden frame.

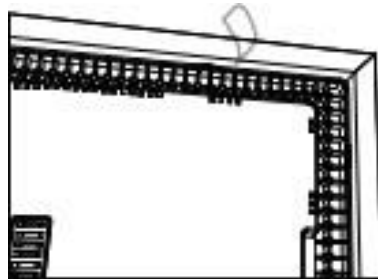

3. Applying slight pressure, push to separate the wooden frame from the display.

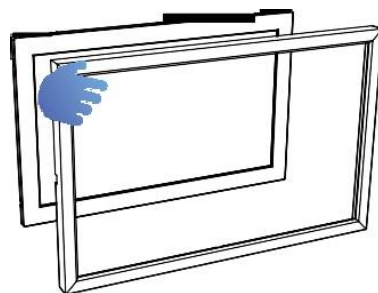

- 
4. On the rear of the display, rotate the turntable plate anti-clockwise from position A to position B.

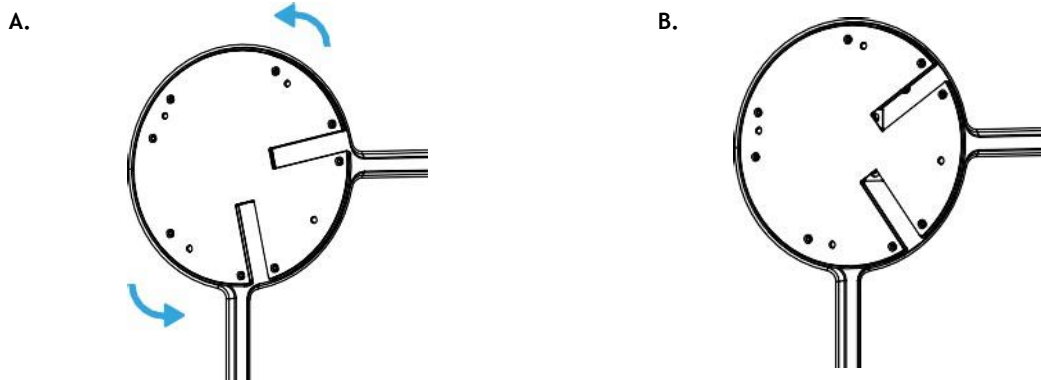

5. Remove the turntable plate from the display.

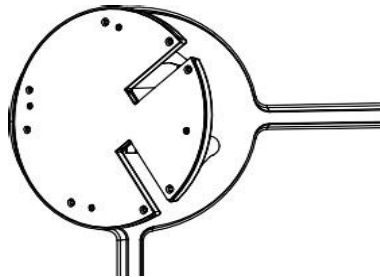

6. Using the double-sided sticky tape provided, fix the paper mounting guide to the wall in the desired location and orientation (landscape or portrait).

Note: Check the mounting guide is levelled by using the spirit level provided.

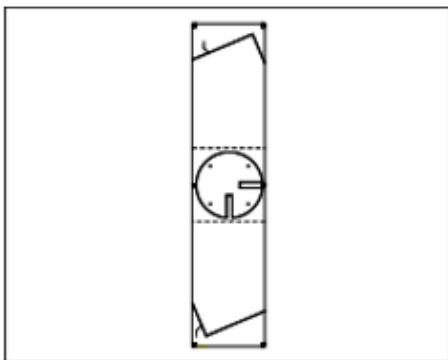

Portrait

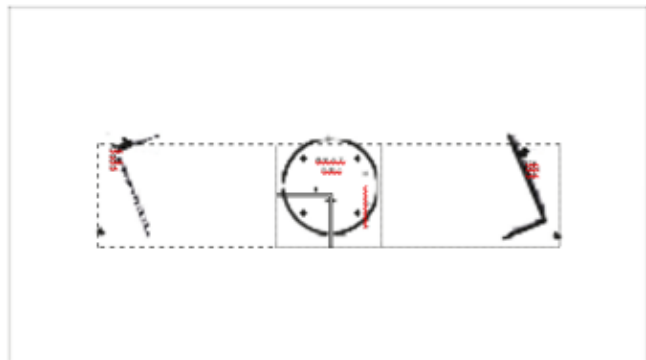

Landscape

- 
- Fix the turntable plate to the wall with the screws provided in the accessory bag using the installation paper as a guide for the position of the plate.

Note: The screws provided may not be suitable for your wall type. \*

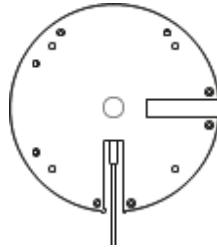

- Insert the power cable into the power input of the turntable plate.
- Using the mounting guide as a reference, mount the display to the pegs of the turntable plate.

Note: Make sure the wire groove on the monitor is facing down.

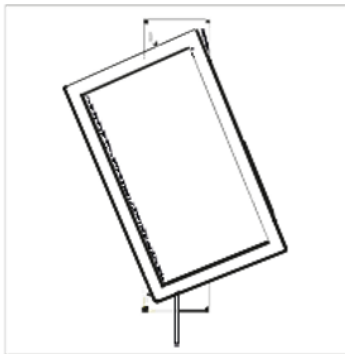

Portrait

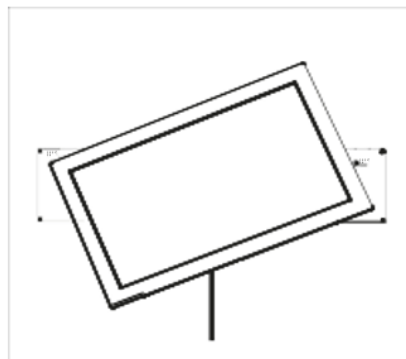

Landscape

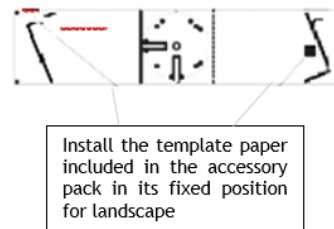
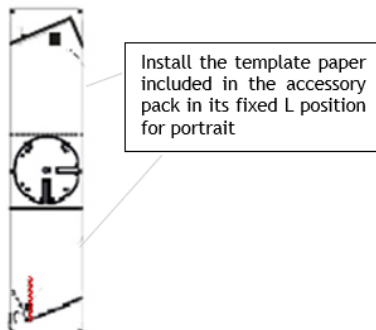

---

**10.** Turn the monitor clockwise into position until it locks in place.

**11.** Take the wooden frame and, making sure the notch on the rear is also facing down, attach the wooden frame until you hear a soft click. Make sure to feed the power cable through the notch on the inside of the frame on the bottom.

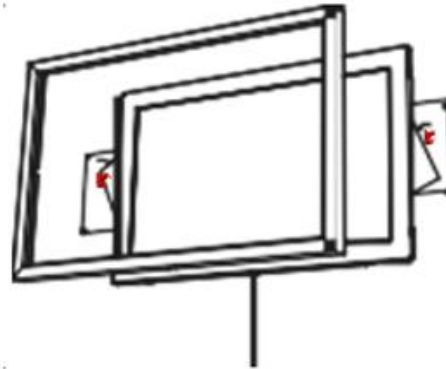
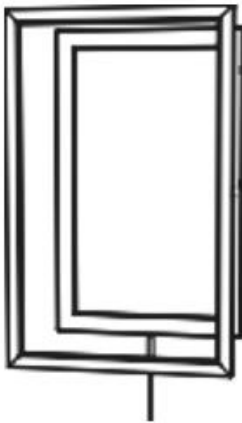

Portrait

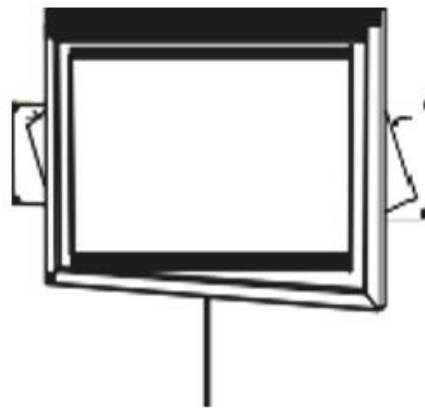

Landscape

---

12. Remove the mounting guide by tearing of the visible sections.

13. Finish the installation by using the spirit level to level the canvas.



Portrait

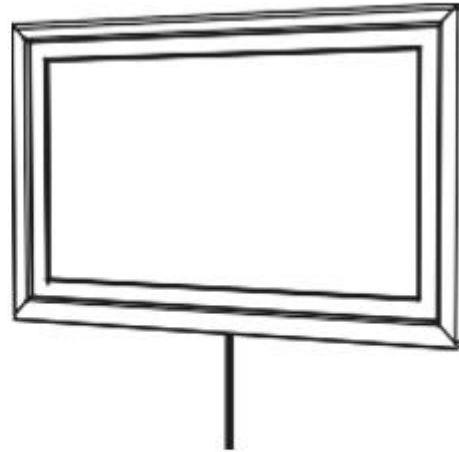

Landscape

---

## Ventilation

If you are mounting your canvas in an enclosed space or recessed area, it is crucial to provide sufficient room between the canvas and the enclosure to allow proper heat dissipation. For effective ventilation, we recommend the following minimum space:



If you plan on mounting your canvas digital frames next to each other, it is important to consider the need for additional ventilation space at the rear of the screens. Please ensure that there is ample room for proper airflow to prevent any potential heat build-up.

## Supported Media Formats

Media Type	Supported File Type	
Image	JPEG	Baseline
Video	MPG, AVI, MP4	MPEG-1, MPEG-2, MPEG-4, Xvid, DivX, H264

1. This unit does NOT support WMV or FLV video file types.
2. This unit does NOT support Sony ATRAC3, DTS or Dolby HD audio file types.

**Note:** Video and image files should be a maximum 1920x1080 resolution for landscape (16:9 aspect ratio) and 1080x1920 for portrait (9:16 aspect ratio).

---

# Navigating the Mobile App

The Vieunite mobile application offers a range of tools for controlling the Vieunite digital canvas. Additionally, it allows users to upload and share artwork within the community. With the Vieunite app, you can conveniently access these features and enhance your experience with the canvas.

## Login screen

Upon launching the application for the first time, you will be presented with the login screen. This screen enables you to log into the application using your designated account. Simply enter your credentials or choose to sign in with a social media platform of your choice to get started. Alternatively, if you prefer to explore the artwork without creating an account, you can select the "Continue As Guest" option.

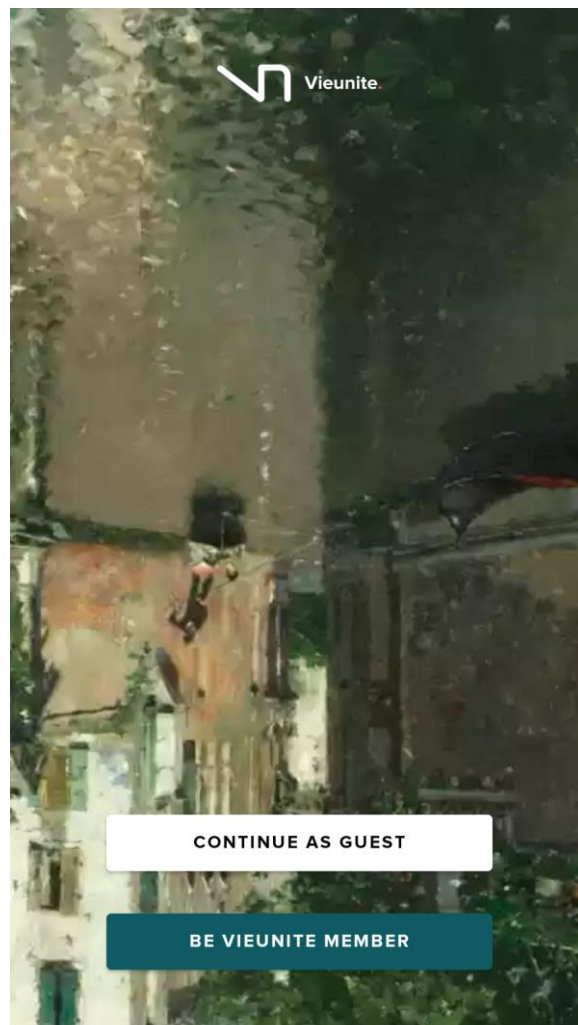

---

## Signing up

To sign up for the application, please enter your email address into the provided field to initiate your Vieunite experience. You will then receive an input code that you can use to proceed with the signup process.

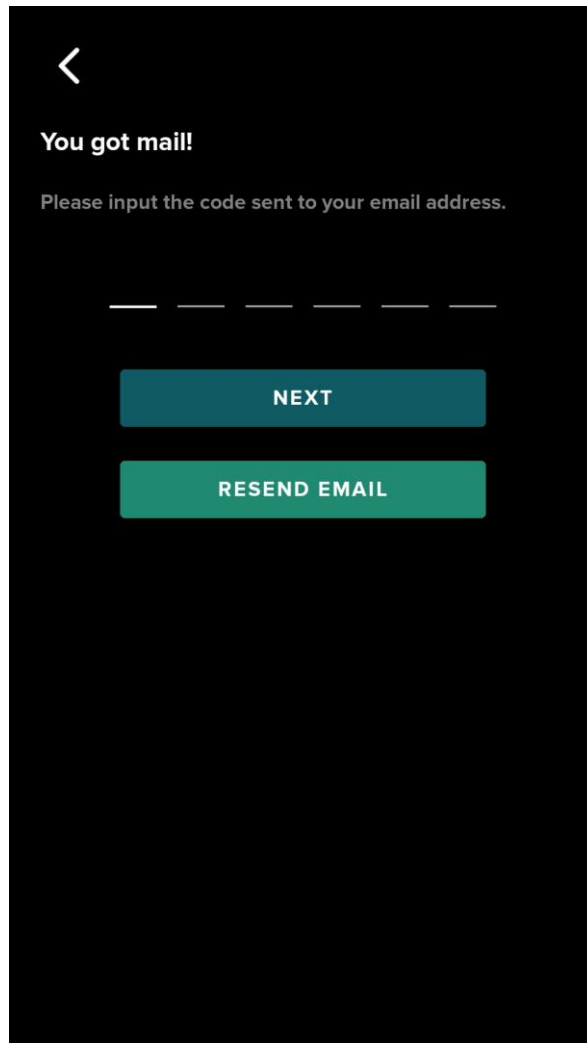

---

## Homepage

On the home screen, you have the ability to navigate through a curated collection of art that is tailored to your preferences or based on the most popular choices among users. You can select any artwork that catches your interest and scroll down continuously to explore a wide range of art suggestions.

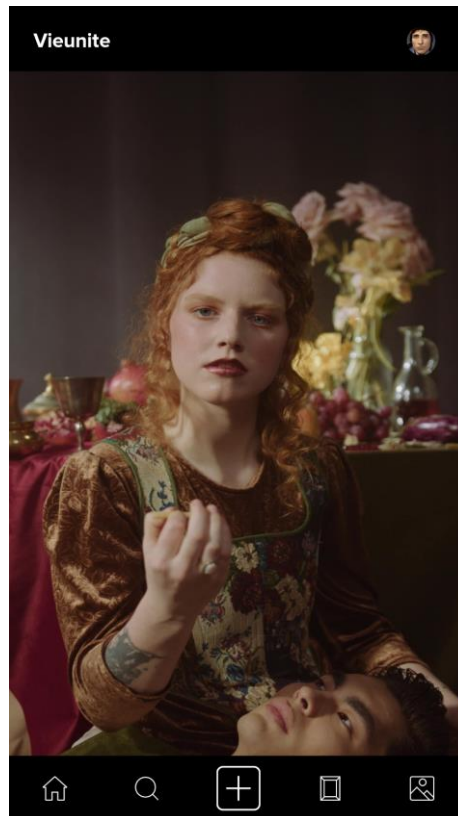

## Navigational Menu

The navigation bar provides easy access to various sections of the application. You can navigate to the following options:

1. Home-page: This takes you back to the main page of the application.
2. Search bar: You can use this to search for specific content or artwork.
3. Upload art: This option allows you to upload your own artwork to the application.
4. Canvas: Here you can access and control your Vieunite Canvas.
5. Library: This section contains your personal library of saved and favorited artwork.



---

## Search page

Within the search page, you will have the opportunity to explore a vast array of art and discover talented artists from around the world. Vieunite is a platform that brings together a diverse range of artistic expressions for your exploration and appreciation.

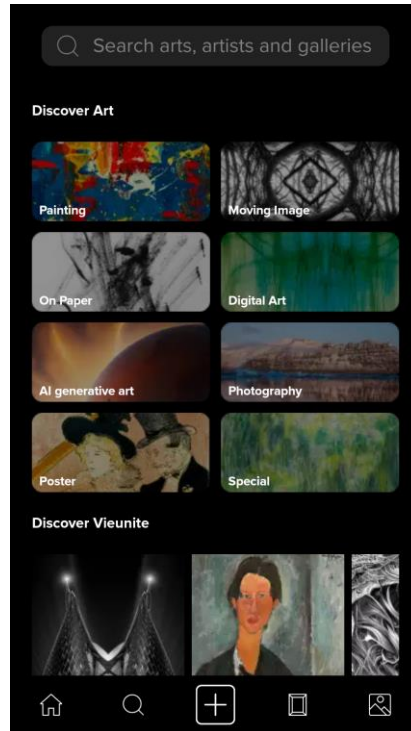

You can refine your Vieunite search by using different parameters or syntax. These more advanced search techniques can help you hone in on just what you're looking for. Remember, you can add more text to a parameter search to narrow it (for instance, *year:1960-1969 "Abstract"*). This table gives you the different search types you can use.

Search Type	Example
Genre	genre: Abstract
Artist	artist: martin_creed
Album	album: "Life drawings"
Year	year: 2009
Range of years	year: 2000-2011
User	User: lousebourgeois



Search  Cancel

Recent Clear

- Louisebourgeois ×
- 2009 ×
- Life Drawings ×
- Abstract ×
- Martin Creed ×

---

## Uploading art

To upload your desired artwork, simply select the art you wish to upload and tap on the "Upload" button once you have completed the process. Upon uploading, the artwork will automatically be added to your personal library, ensuring easy access and organisation of your uploaded pieces.

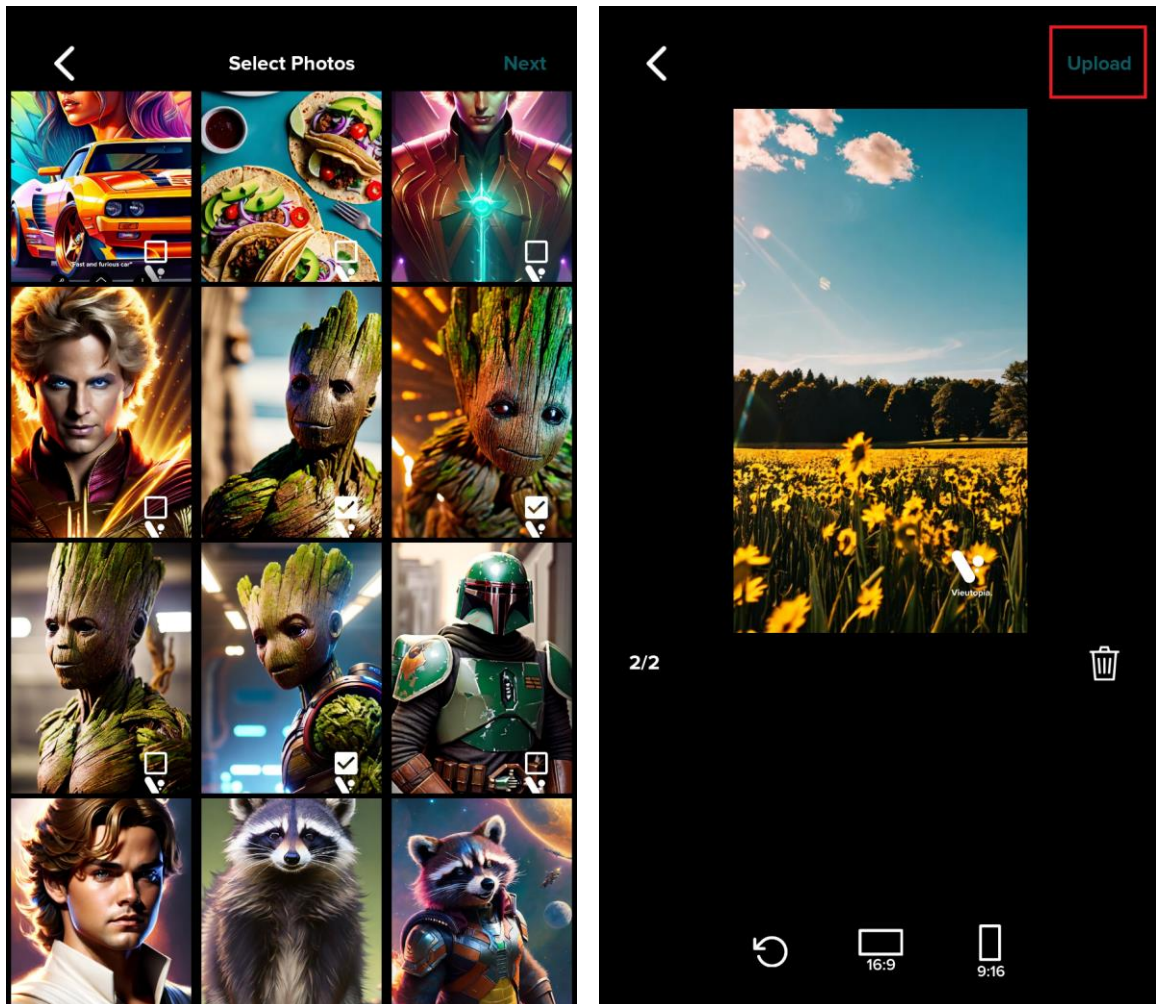

Please be aware that all uploaded artwork is strictly for personal use only. If you intend to sell artwork, we kindly request that you utilise the artist portal, which can be accessed through the following link: <https://vieunite.com/artistportal/login>. This portal provides the necessary tools and resources for artists to showcase and sell their creations.

**Please note:** The maximum number of images users can upload in one batch is currently 20. All images uploaded will be stored in the "personal folder".

---

## User Options

Upon accessing the user options page, you will discover a plethora of customisation features for both the application and your profile. These options are categorised into five distinct sections:

- **Store:** This section enables you to review the contents of your shopping bag and access your previous orders.
- **Notifications:** Here, you can conveniently view all notifications and messages received from other users.
- **Artists:** This section grants you access to your artist profile. It includes the artist dashboard, which provides a range of statistics for artists who sell their artwork. You can also track your current artist level.
- **Account Settings:** Within this category, you can customise your profile, adjust app preferences, and make general edits to your account.
- **About:** This section allows you to provide feedback for the application, access the terms of use, and review the privacy policy.

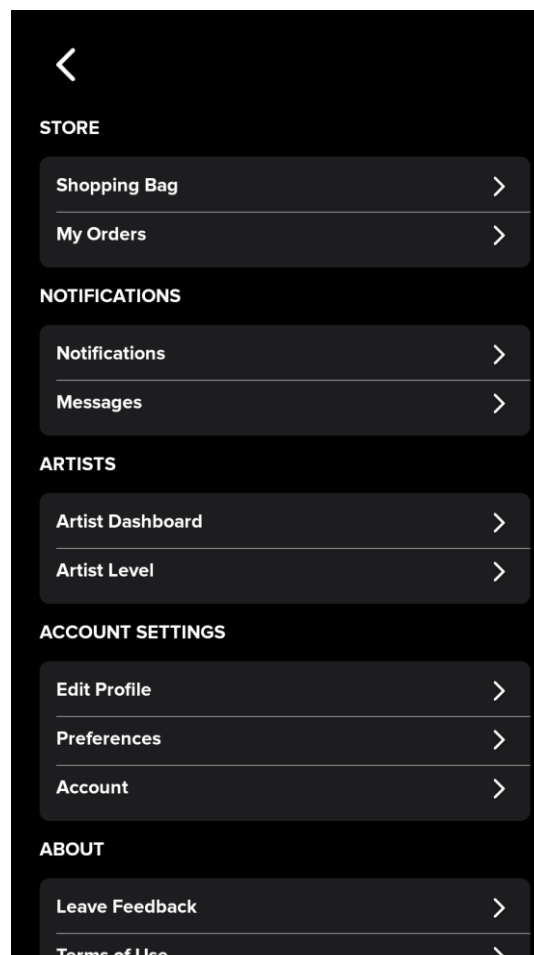

---

## Library

On the Library page, you have the ability to navigate through all the art you have purchased or uploaded. You can select individual artworks, apply filters to narrow down your choices, and even create customisable albums to organise your collection. Take advantage of these features to easily browse and manage your art within the Library.

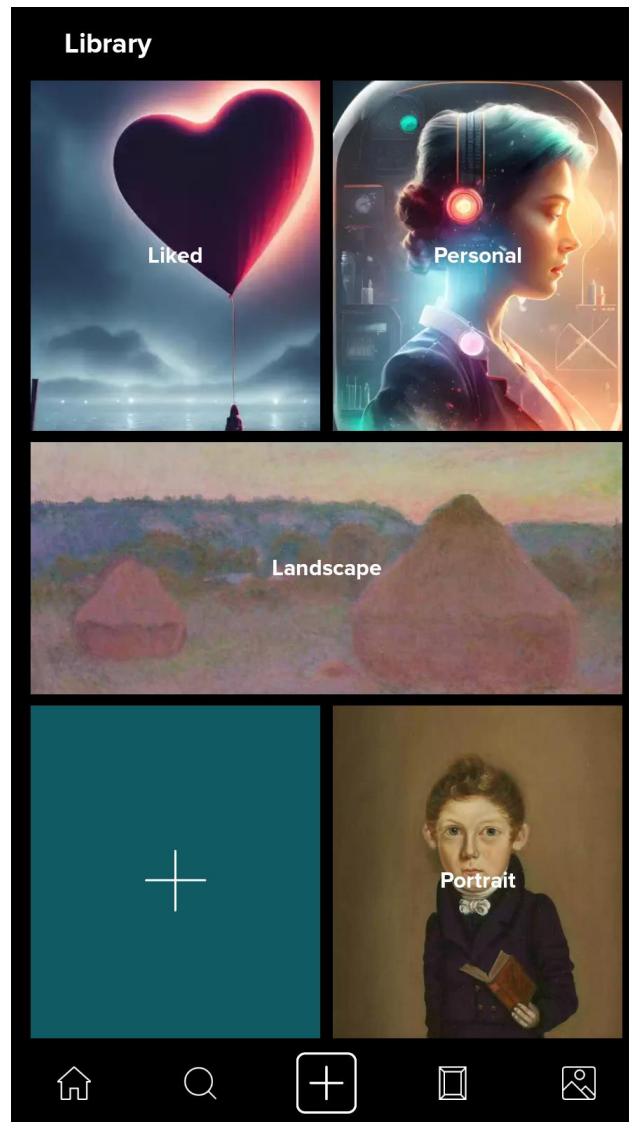

---

## Album

On the Album creation page, you have the ability to create personalised albums and organise the art you have purchased or uploaded. Each album can be customised according to your preferences. You can select specific artworks, apply filters to refine your selection, and add them to the desired album.

Within each album, you have various editing options available. You can rename the album, make edits to its contents, add new artworks to the album, assign the album to your canvas, or even delete the album altogether. These features allow you to curate your collection and manage your albums based on your preferences and artistic choices.

It is recommended to organize all personal uploaded images into the albums to gain ease of access and best viewing experience.

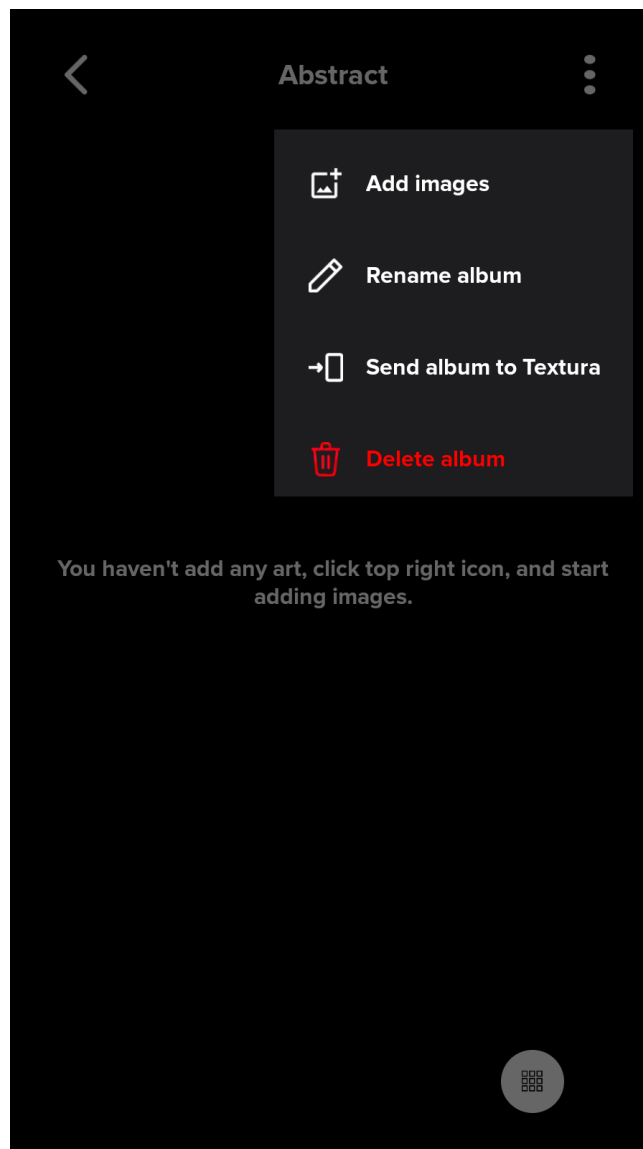

---

## Artist Dashboard

The Artist Dashboard serves as your primary navigation menu for listing and managing your art transactions. It provides comprehensive information and features related to your artist account. Within the Artist Dashboard, you will find the following:

- **Listings:** View all your current art listings in one place.
- **Account Balance:** Monitor the balance of your account and track your earnings.
- **Payment History:** Access a record of your past payment transactions.
- **Followers:** See the list of users who are following your artist account.
- **Following:** View the accounts you are following.
- **Account Editing:** Make edits and updates to your artist account settings.
- **New Artist Account Setup:** Set up a new artist account if you are just starting out.

The Artist Dashboard is designed to provide you with comprehensive control over your artist account, enabling you to manage your listings, track your earnings, and customise your account settings. This can only be accessed via the web URL.



Enter the following URL into the web browser of your PC to access full control of your dashboard.

<https://vieunite.com/artistportal>

**OPEN MOBILE VERSION**

---

## Canvas page

On the Canvas page, you will find a comprehensive listing of all available canvases on the market that are ready for purchase. This section provides detailed technical information and specifications for each canvas, allowing you to make informed decisions based on your specific requirements. Explore the Canvas page to find the perfect canvas that meets your needs and preferences.

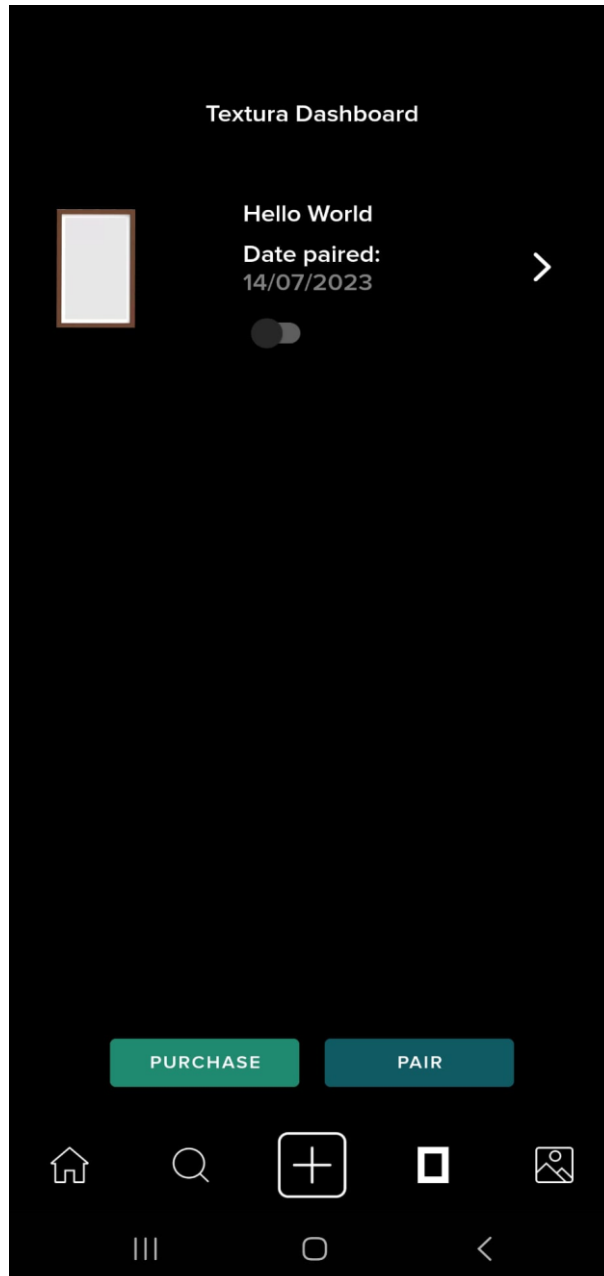

---

## Pairing Your Canvas - Bluetooth

To pair your canvas via Bluetooth, follow these three simple steps. Please refer to **page 3** for the quick start guide.

**Step 1:** Select your Textura device from the list of nearby Bluetooth devices.

**Step 2:** Confirm the connection and enter your Wi-Fi details to connect your canvas to the network.

**Step 3:** Assign a name and orientation to your canvas to complete the setup.

Once these steps are completed, your canvas will be successfully paired and ready to use.

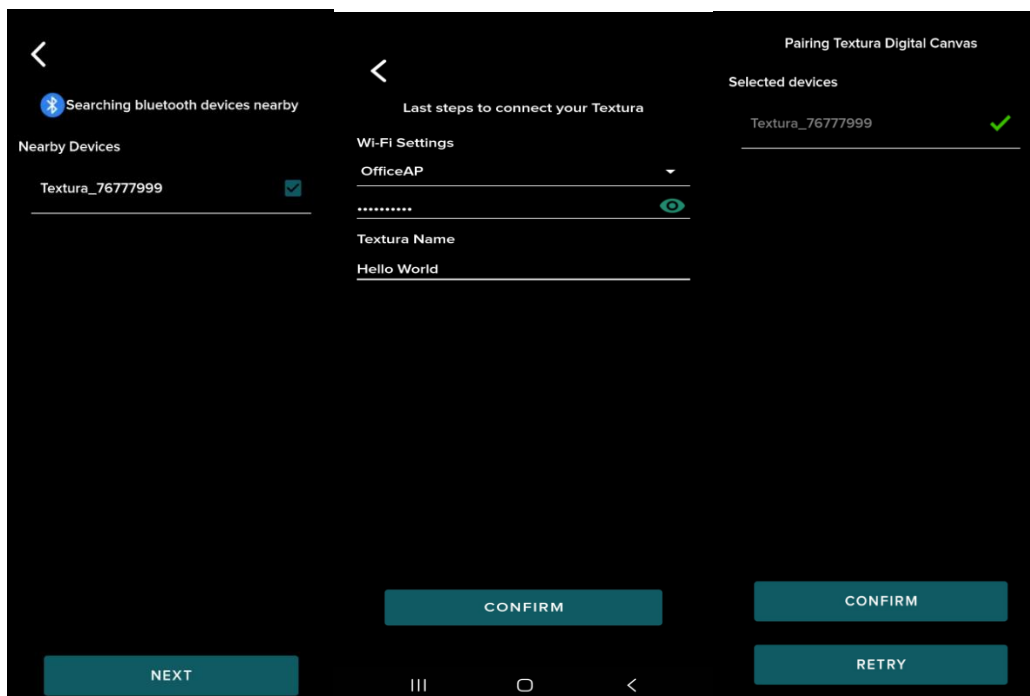

---

## Pairing Your Canvas - QR Code

To pair your canvas, you will need to follow three simple steps. Please refer to **page 3** for the quick start guide.

**Step 1:** Scan the QR code displayed on your canvas screen to proceed with the pairing process.

**Step 2:** Connect to your canvas's hotspot.

**Step 3:** Connect your canvas to your Wi-Fi network and select a name and orientation for your Canvas.

By completing these three steps, you will successfully pair your canvas and be ready to enjoy its features.

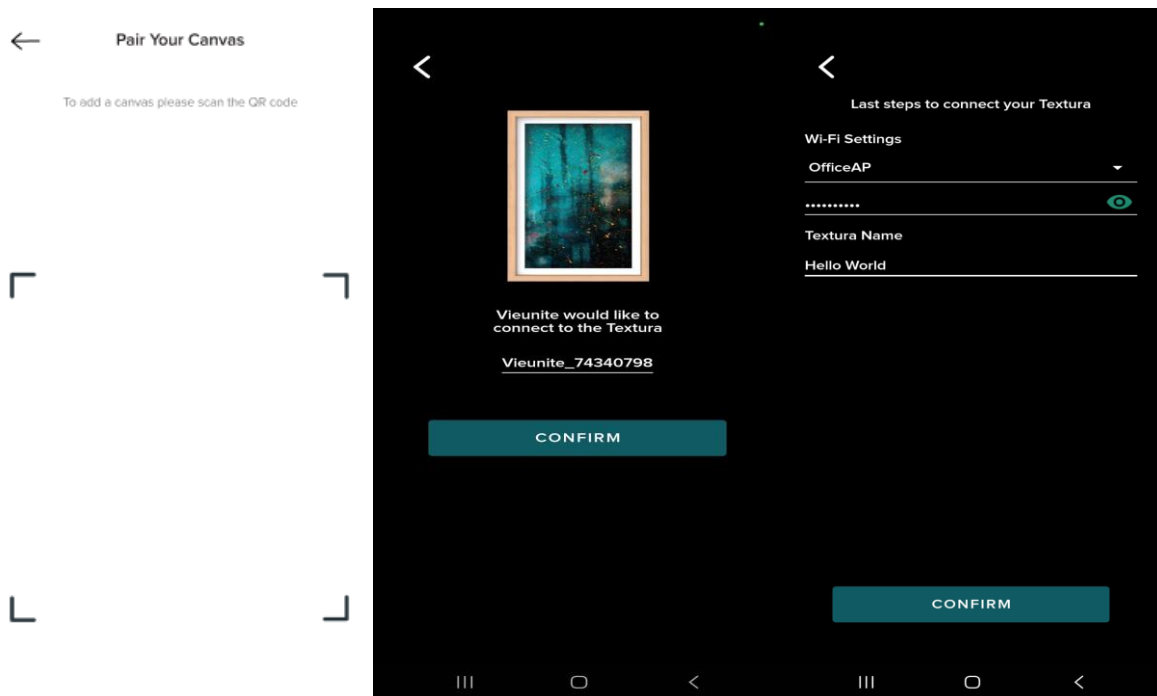

---

## Canvas Settings

On this page, you will have the ability to customise the settings of the digital canvas that is connected to your account according to your preferences.

The following options are available for editing:

- **Control:** Use this option to control the screen and its functions.
- **Schedule:** Set up the on/off timer to schedule screen activation and deactivation.
- **Orientation:** Adjust the orientation of the canvas to suit your desired display position.
- **Volume:** Modify the volume level on the canvas.
- **Brightness:** Adjust the brightness level of the canvas.
- **Image Duration:** Change the duration for which each image is displayed.
- **Change Textura Name:** Rename your Textura Digital Canvas.
- **Factory Reset:** Reset the device to its factory settings.
- **Shutdown:** Remotely power off the device.
- **Un-pair Textura:** Remove the device pairing remotely.

These settings allow you to personalise your Textura digital canvas and tailor it to your specific preferences and requirements.

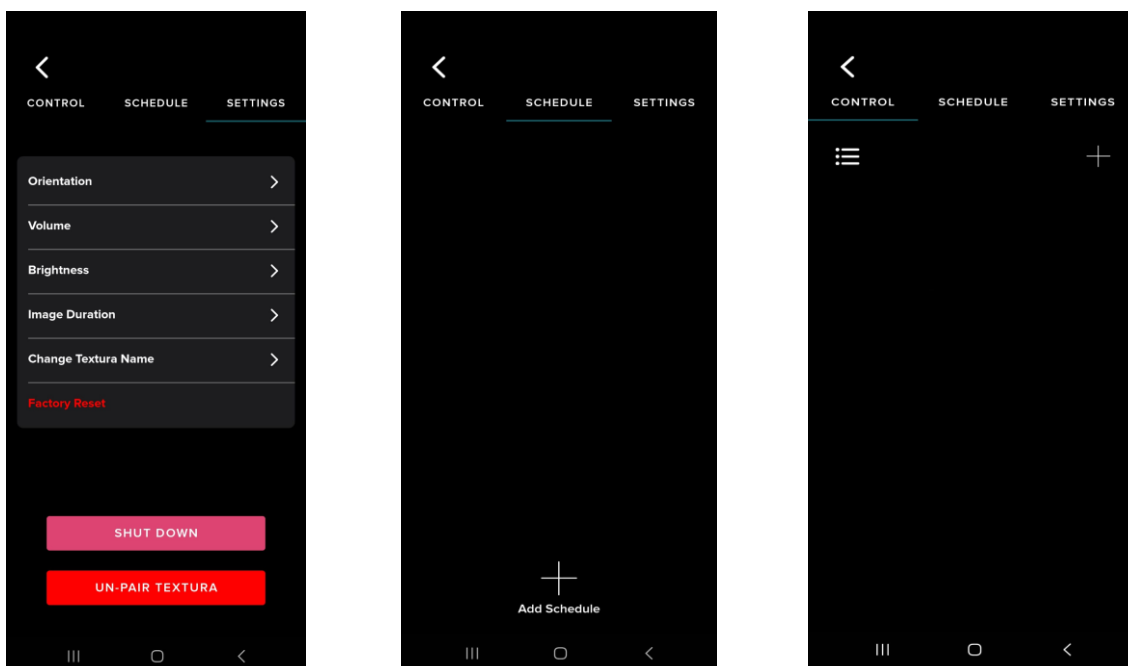

---

## Art Selection

When you tap on a piece of art that you discover on the home page or within your community, you will be directed to the comprehensive art information page for the selected artwork. Here, you will find detailed information about the art itself and the associated artist.

In addition, you will have various options available, including:

- **Purchase:** You can choose to purchase the art directly from the information page.
- **Favorite:** Add the art to your personal collection of favorites.
- **Preview:** Get a preview of how the art will look displayed on your canvas.
- **Share:** Share the artwork with others through various sharing options.
- **Add to Album:** Add the art to an album for future purchase or reference.
- **Report:** If you find the art to be inappropriate or in violation of application guidelines, you can report it.

These options provide you with flexibility and control over how you engage with the art and artists within the application.



---

## Purchasing Art

When you have identified a piece of art that you would like to purchase, you will need to complete four simple steps to proceed with the transaction:

- **Step 1:** Select the "Add to Bag" button to add the desired artwork to your shopping bag.
- **Step 2:** Navigate to your shopping bag to review the items you have added.
- **Step 3:** Provide the necessary information for your preferred payment method.
- **Step 4:** Take a moment to review and confirm your order before finalising the purchase.

By following these four steps, you will successfully complete the purchase process and secure the artwork you have chosen.

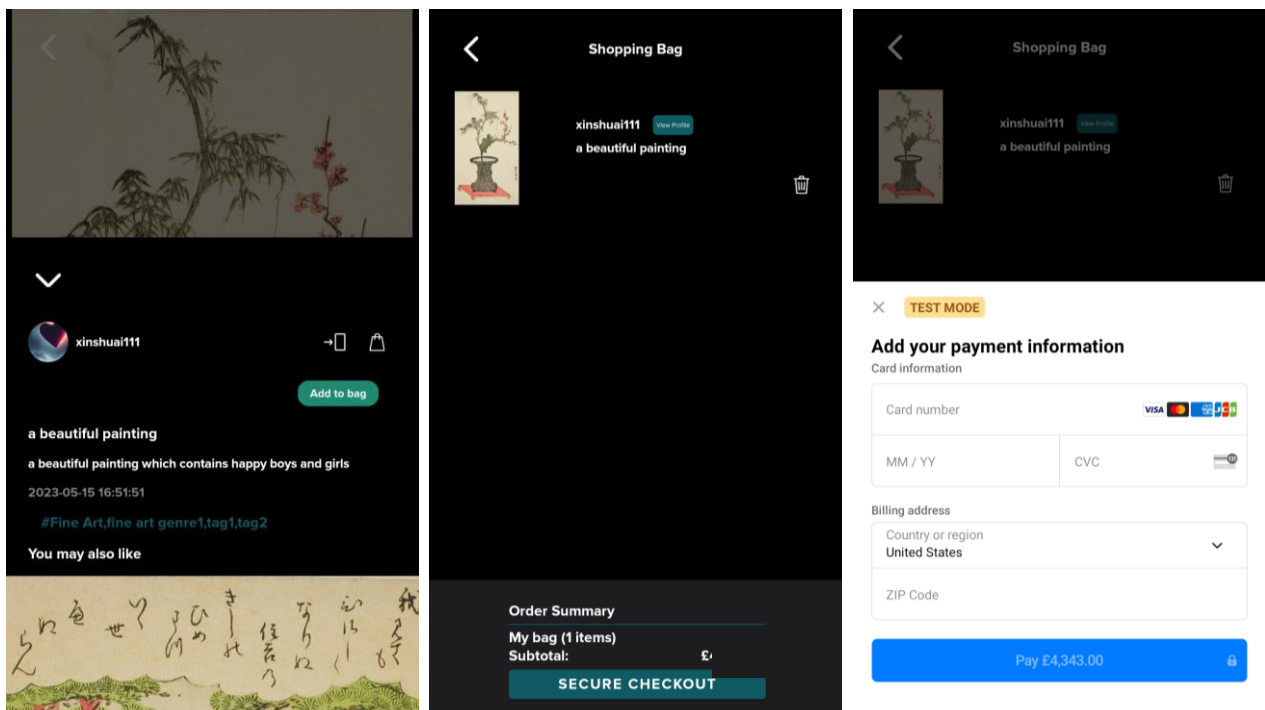

---

# FAQs and Troubleshooting Guide

## My art looks stretched, unfocused or blurry

Please ensure your content is created using the following format and resolution to ensure the best image quality on the canvas:

*Image:*

Container	JPEG
Compression	Baseline
Colour Mode	RGB
Width	1920 (1080 for portrait)
Height	1080 (1920 for portrait)
DPI	300

*Video*

*Required:*

Container	MP4, AVI, MPG
Codec	MPEG-1, MPEG-2, MPEG-4, XVID*, H.264
Width	1920 (1080 for portrait)
Height	1080 (1920 for portrait)
Audio	AAC or MP3

---

## How do I reset my device to factory default?

To reset the device completely, please follow these steps:

1. Remove your canvas from the wall and turn it around to access the back.
2. Locate the area pictured below on the back of the canvas.
3. Take a small object, such as a paperclip, and insert it into the circled area.
4. Keep the object inserted for approximately 1 second until the device is completely reset.

By performing these steps, you will successfully reset the canvas device to its default settings.



## My Device won't turn on

Please confirm that your canvas is connected to a functional wall socket and ensure that the socket is switched on. Additionally, check that the USB Type-C connection is securely plugged into the canvas.



---

## Managing Images on your Canvas:

The Vieunite Home canvas is designed to efficiently display your artwork while keeping performance optimized. Currently, the canvas can store up to 230 images from the server at a time.

- When uploading more than 230 images, new uploads will replace the oldest images stored on the canvas.
- To ensure all preferred images are displayed, we recommend managing uploads in smaller batches.
- Images are stored in a single collection, so while albums are a great way to organize artwork in the Vieunite app, they are not reflected as separate categories on the canvas itself.
- Users can browse through images manually and remove artwork individually as needed.

We are continuously working on improvements to enhance album management and image handling on the canvas in future updates.

---

# Specifications and Other Information

## Product Overview



## Technical specifications

LCD Panel size	27" LED
Active Screen Size	597.888x336.312 mm
Pixel Format	1920x1080
Panel luminance	250 to 300 cd/m <sup>2</sup>
Colour Ratio	700 to 1000
Colour Depth	8bit, 16.7million colours
Response Time	15 to 25 ms
Gross Weight	8.2 KG
Net Weight	5.4 KG
Speakers	1.5W
CPU	UNISOC UIS8581 /8 Core Cortex A55
RAM	2GB LPDDR4
Storage	32GB eMMC
VESA	100x100

---

## Environmental Considerations

Operating Temperature	0 °C to 50 °C
Storage Temperature	-30 °C to 60 °C
Operating Humidity	10% to 80%
Storage Humidity	5% to 95%

## Decreasing power consumption

When you turn off the canvas it enters Standby mode, which still consumes a small amount of power. To minimise power consumption, it is recommended to unplug the power cord when the canvas will not be used for an extended period.

## Disposal

Correct Disposal of This Product (Waste Electrical & Electronic Equipment) (Applicable in countries with separate collection systems) This marking on the product, accessories or literature indicates that the product and its electronic accessories should not be disposed of with other household waste at the end of their working life. To prevent possible harm to the environment or human health from uncontrolled waste disposal, please separate these items from other types of waste and recycle them responsibly to promote the sustainable reuse of material resources. Household users should contact either the retailer where they purchased this product, or their local government office, for details of where and how they can take these items for environmentally safe recycling. Business users should contact their supplier and check the terms and conditions of the purchase contract. This product and its electronic accessories should not be mixed with other commercial wastes for disposal.



## Warnings

Image retention, commonly known as screen burn-in, can occur on most types of LCD panels if the same image is displayed continuously. The most common causes of image retention are logos that remain stationary on the LCD panel. To reduce this risk, avoid displaying still images for long durations and lower the brightness settings to decrease the intensity of the picture. Extended viewing of art in aspect ratios that are different from the aspect ratio of the panel may cause image retention. Always try to avoid black borders at the top or bottom by using correct image/video resolution. This will help eliminate the black borders and fit the picture to the entire area of the screen.

- **IMPORTANT:** Image retention issues are not covered by your Vieunite® warranty

---

## Warranty

This Vieunite product is warranted for a period of twelve (12) months from the original date of purchase, against defective materials and workmanship. In the event that warranty service is required, you should return the product to the seller from whom it was purchased. In case of difficulty, details of our Authorised Service Centres are available from:

Vieunite Ltd,  
Allsee Building,  
38 Kettleswood Drive,  
Woodgate Business Park,  
Birmingham,  
B32 3DB

**United Kingdom**

Tel: +44 (0)121 421 4458

[www.vieunite.com/support](http://www.vieunite.com/support)

## Warranty Conditions

1. The warranty provided by Vieunite covers any defects and malfunctions in the canvas device. If the unit is found to be defective, Vieunite will support either repair or replacement of the affected unit.
2. Replacement units may consist of new or refurbished screens or parts, depending on the specific issue.
3. To initiate a return, it is necessary to retain the original packaging.
4. All returns must be made by mail and will be refunded to the original form of payment.
5. Proof of purchase is required for warranty claims, unless the purchase can be verified in advance.
6. If a product cannot be repaired or replaced, a refund will be provided.
7. In the absence of proof of purchase or if the product is not covered by this warranty, Vieunite reserves the right to return the product at the customer's expense, subject to prepayment. If such costs are not prepaid, the product will be kept for 30 days for collection by the customer before disposal.
8. The warranty does not cover wear and tear, accidents, consumable parts, or cosmetic damage for repair or replacement.
9. This warranty also applies to defects in materials and workmanship of the product as packaged in the original packaging.

---

# Ongoing Improvements & Future Updates

Feature/Improvement	Description
<b>Increased Upload Limit</b>	The current limit of 20 images per upload will be expanded to support larger batches, ideally matching the album limit.
<b>Bulk Selection for Uploads</b>	Users will be able to select multiple images at once instead of clicking one by one.
<b>Easier Image Deletion</b>	A batch delete function will allow users to remove multiple images from the canvas at once, rather than deleting them one by one.
<b>Image Storage Transparency</b>	Users will be able to see all stored images on the canvas, view total storage space, and receive a warning for duplicate uploads.
<b>Improved Image Organization</b>	Images uploaded to the canvas will mirror album structures, rather than merging into a single unorganized list.
<b>Album Enhancements</b>	Each album will display the number of images stored, including default ones (Personal, Horizontal, Vertical).
<b>Google Drive &amp; Cloud Integration</b>	Users will soon be able to sync and upload images from Google Drive and other cloud-based platforms.
<b>Art &amp; Viewing Experience</b>	Improvements to image transitions and playlist management for a smoother visual experience.